



Cover 3:
Albie Calico

Cover 1:
Kairo Bottle Green

Cover 2:
Brassan Forest

Walnut Foot

Utopia Collection

DuoFlex

Colours represented are to be used as a guide only.
Please refer to manufacturers swatch for a more accurate colour match.

Please note that colour shadings can vary slightly from each roll of fabric.
We cannot guarantee a precise match to these samples or between cut lengths and upholstered goods.

20/02/2024

UTOPIA COVER GUIDE: STANDARD BACK

Please use this guide when ordering the following pieces to clarify cover options.

LH2, RFC, FST Group

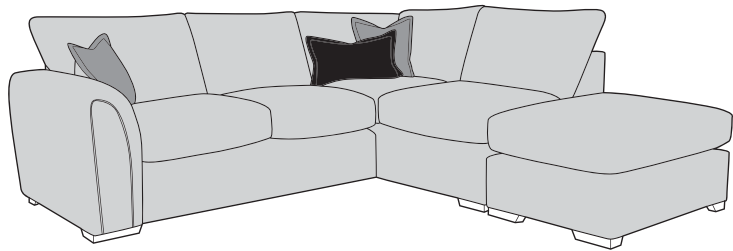

3 Seater Sofa - 3ST-S-C

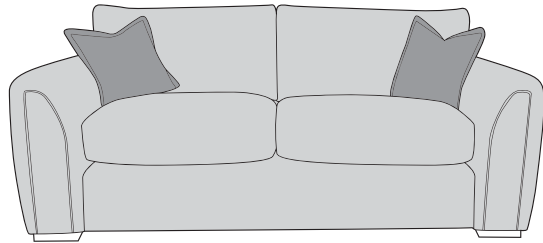

Love Chair - LOV-S-C

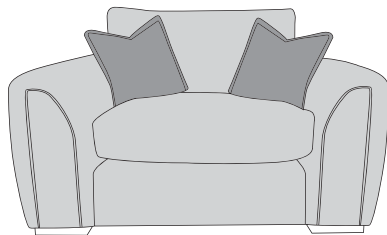

3 Seater Deluxe Sofa Bed - 3DB-S-C

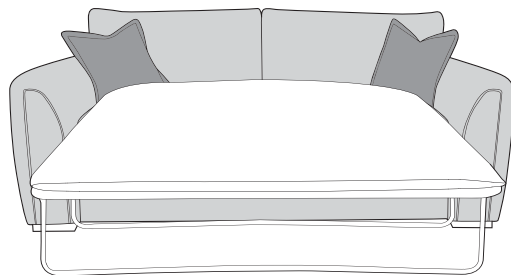

FST, LFC, RH2 Group

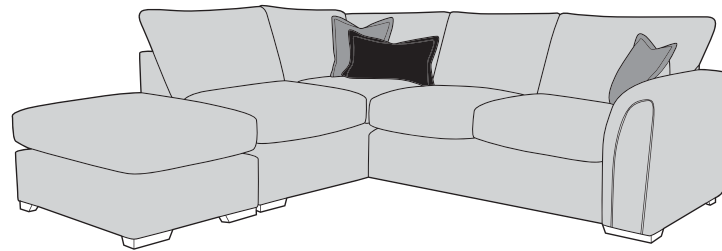

2 Seater Sofa - 2ST-S-C

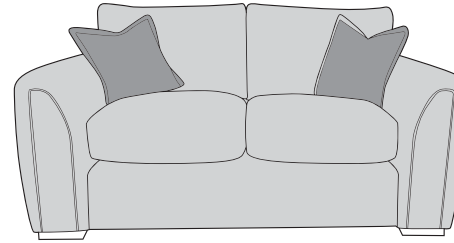

Arm Chair - 1ST-S-C

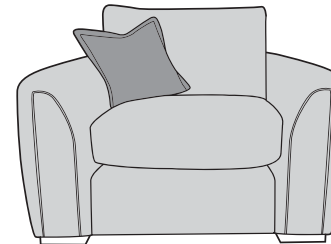

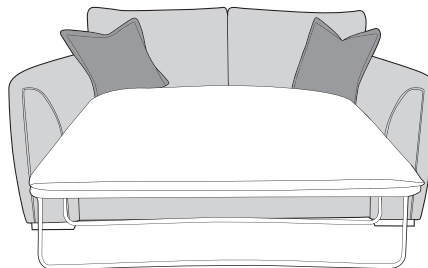

2 Seater Deluxe Sofa Bed - 2DB-S-C

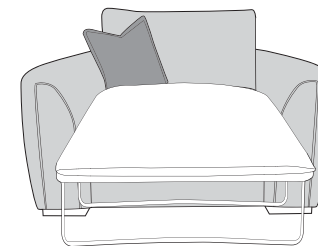

Chair Deluxe Sofa Bed - 1DB-S-C



-  **COVER 1**
(BODY)
-  **COVER 2**
(SCATTER)
-  **COVER 3**
(BOLSTER)

Scatter Cushions

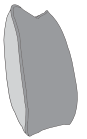

Front = Cover 2
Back = Cover 1
Flanged Edge

Bolster Cushion



Front = Cover 3
Back = Cover 3
Flanged Edge



APPROVED MEMBER



UTOPIA COVER GUIDE: PILLOW BACK

Please use this guide when ordering the following pieces to clarify cover options.

LH2, RFC, FST Group

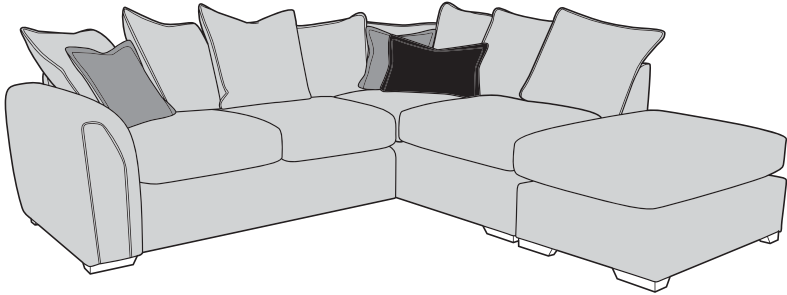

LFC, RH2, FST Group

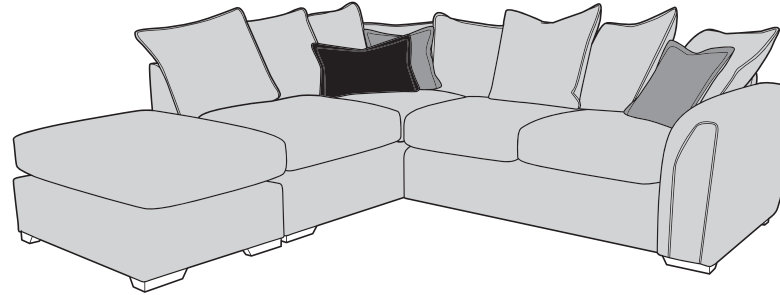

3 Seater Sofa (3ST)

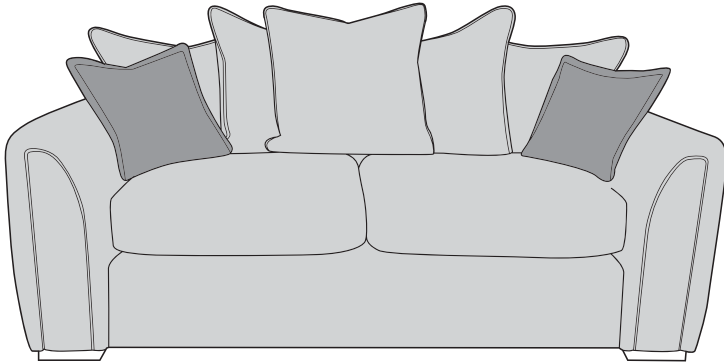



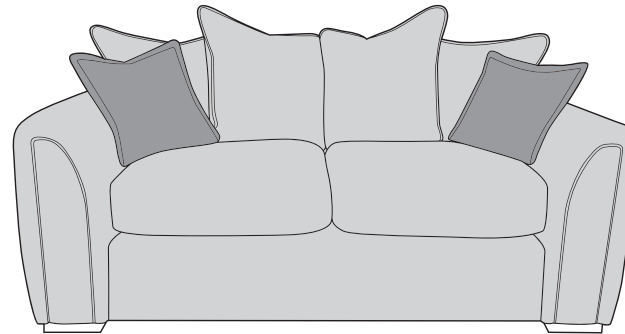

2 Seater Sofa (2ST)

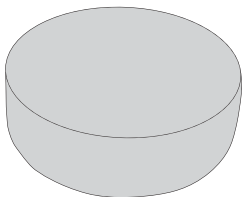

SUGGESTED ACCENT PIECES

Arc Footstool (FST)



-  **COVER 1**
(BODY)
-  **COVER 2**
(SCATTER)
-  **COVER 3**
(BOLSTER)

Pillow Back Cushions

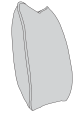

Front = Cover 1
Piping = Cover 1
Back = Cover 1

Scatter Cushions



Front = Cover 2
Back = Cover 1
Flanged Edge

Bolster Cushion



Front = Cover 3
Back = Cover 1
Flanged Edge



APPROVED MEMBER



UTOPIA DIMENSIONS (CM)

AVAILABLE PIECES	HEIGHT 1	WIDTH 2	DEPTH 3	SEAT HEIGHT 4	SEAT DEPTH 5	SEAT WIDTH 6	ACCESS DIAGONAL 7	OUTBACK HEIGHT 8	ARM HEIGHT 9	WEIGHT (KG)	SCATTER CUSHIONS
CORNER GROUP: LH1.5, RFC, FST or FST, LFC, RH1.5	95	256	247	54	N/A	N/A	N/A	73	68	119.5	2 SCATTERS 1 BOLSTER
LH1.5/RH1.5 UNIT	95	161	95	54	56	137	183	73	68	48	1 SCATTER
LFC/RFC UNIT	95	177	95	54	56	N/A	198	73	N/A	53.5	1 SCATTERS 1 BOLSTER
FOOTSTOOL (FST)	54	70	95	N/A	N/A	N/A	115	N/A	N/A	18	N/A
3 SEATER SOFA (3ST)	95	212	95	54	56	162	227	73	68	57	2 SCATTERS
2 SEATER SOFA (2ST)	95	189	95	54	56	136	205	73	68	53.5	2 SCATTERS
LOVE CHAIR (LOV)	95	144	95	54	56	96	171	73	68	73	2 SCATTERS
ARMCHAIR (1ST)	95	110	95	54	56	62	144	73	68	40	1 SCATTER
SOFA BEDS - OPEN DEPTH 226cm											
140cm DELUXE SOFA BED (3DB)	95	209	95	54	56	159	226	73	68	96.5	2 SCATTERS
120cm DELUXE SOFA BED (2DB)	95	189	95	54	56	136	206	73	68	87	2 SCATTERS
80cm DELUXE SOFA BED (1DB)	95	144	95	54	56	96	171	73	68	74	1 SCATTER
ACCENT PIECES											
ARC FOOTSTOOL (FST)	33	97	97	N/A	N/A	N/A	N/A	N/A	N/A	22	N/A

SOFABEDS: SLEEP OPTIONS

DELUXE ACTION & SPRUNG MATTRESS
 A two fold metal action with beech slats. Complemented by a deluxe sprung mattress. For everyday use.
Mattress thickness: 11.5cm
Mattress Length: 183cm



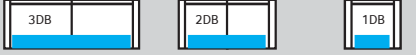

2 fold action is 160Kg total max occupancy weight

140cm sofa bed: 120cm sofa bed: 80cm chair bed:



Mattress Width:132cm Mattress Width:114cm Mattress Width:76cm

Sofa beds available as standard back only

- * Hardwood & composite board frame.
- * Dowelled, screwed, glued & stapled joinery.
- * Available with a choice of Mid Oak & Walnut feet.
- * Reversible, high performance DuoFlex seating.
- * Fibre filled standard backs for added comfort.
- * Sumptuous feather filled pillow backs. 
- * Feather filled scatters and bolsters included. 
- * Serpentine seat springs & silent wire.
- * Elasticated back webbing.

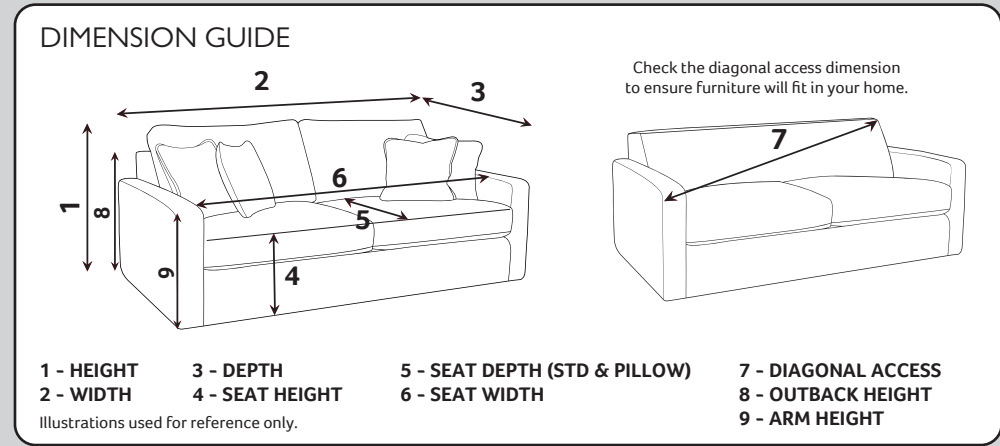

Please note : All dimension are approximate. Allow tolerance of +/- 2.5cm.

DuoFlex

A high density foam seat with a foam wrap. DuoFlex seat cushions are fully reversible.

CARE GUIDE

To improve the longevity of your hand-made furniture, we recommend turning cushions often to ensure even wear over time. For further information on maintaining your furniture, please refer to the Care Guide located under the seat platform.

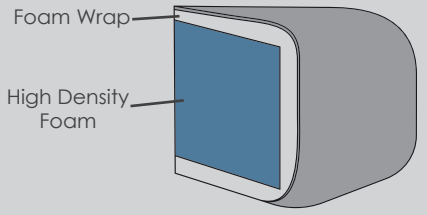

The DuoFlex seat interior has been granted the FIRA GOLD Award, a mark of quality under-pinning all necessary testing of the product materials, design and production techniques.



Mid Oak

Walnut

FOOT OPTIONS:

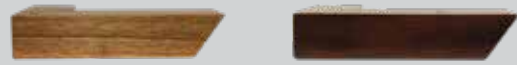

Wood is a natural product and will vary in shade/colour from item to item. Feet may require fitting.

