



Cover 1:  
Polly Cotton

Cover 2:  
Style Pastel

Cover 2:  
Style Pastel

Cover 1:  
Polly Mink

Mid Oak Feet

# Lorna Collection

Colours represented are to be used as a guide only.  
Please refer to manufacturers swatch for a more accurate colour match.

Please note that colour shadings can vary slightly from each roll of fabric.  
We cannot guarantee a precise match to these samples or between cut lengths and upholstered goods.

foamflex™

Award Winning Seating Technology

22/03/2023

# LORNA COVER GUIDE - STANDARD BACK ONLY

Please use this guide when ordering the following pieces to clarify cover options.

## LH3, RFC, FST (L3, RFC, P) Group

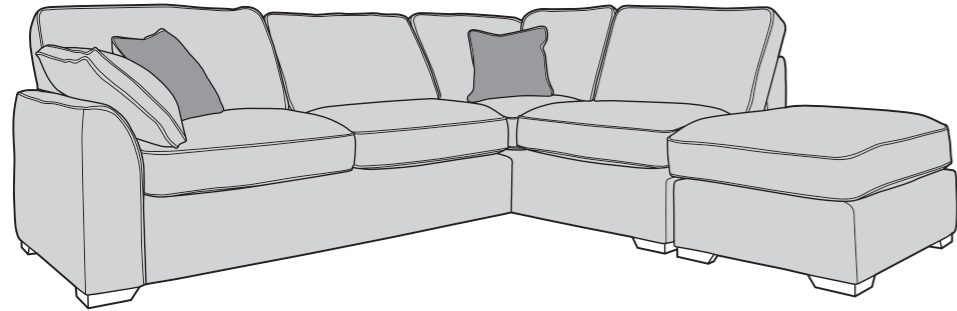

**3 Seater Sofa (3ST)**

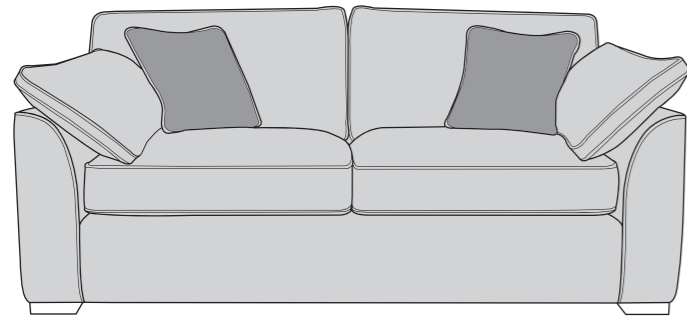

**2 Seater Sofa Bed (2SB/2DB)**

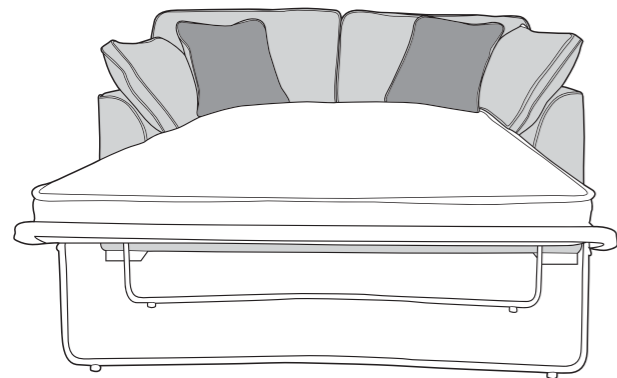

## FST, LFC, RH3 (P, LFC, R3) Group

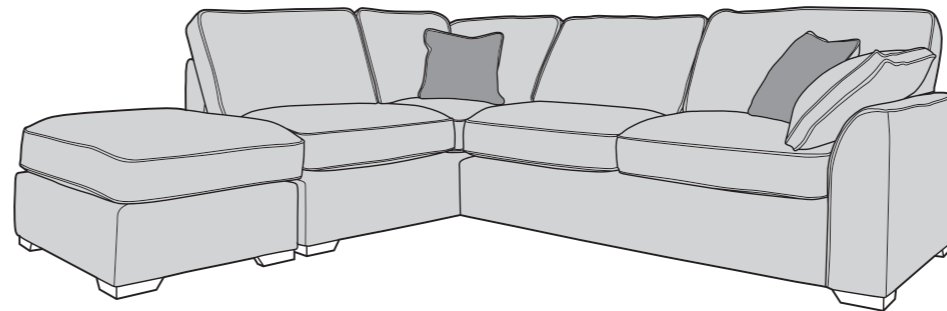

**2 Seater Sofa (2ST)**

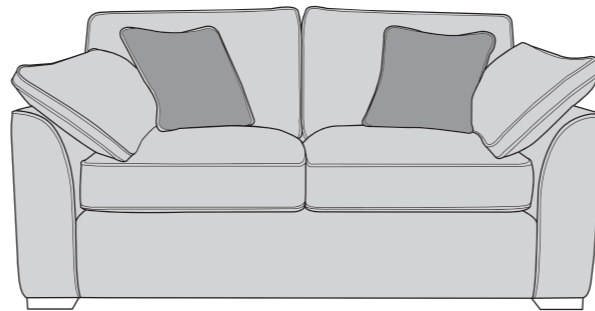

**Love Chair (LOV)**

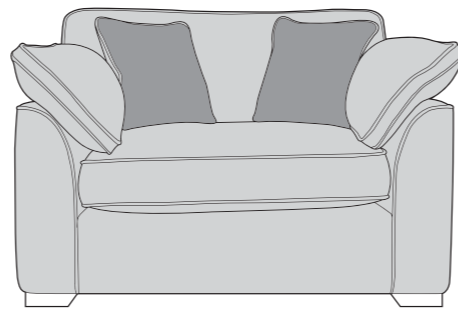

**Arm Chair (1ST)**

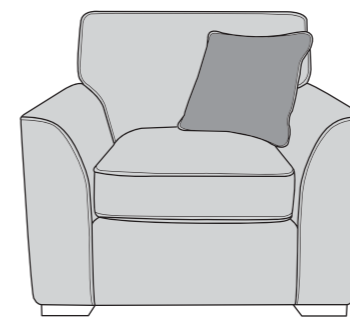

-  **COVER 1**  
(BODY)
-  **COVER 2**  
(SCATTER)

### Scatter Cushions

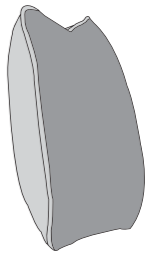

Front = Cover 2  
Piping = Cover 1  
Back = Cover 1

## ACCENT PIECES

**George Accent Chair (ACH)**

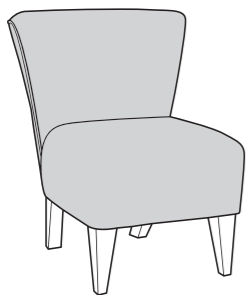

**Large Footstool P (FST)**

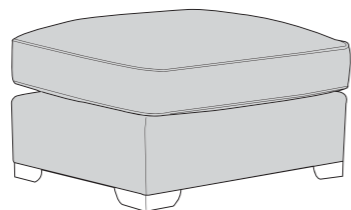

**Storage Footstool (FSS)**

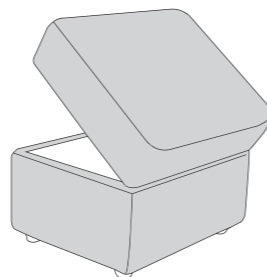

**Large Style Footstool (FST)**

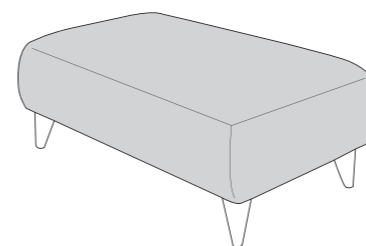

**Small Style Footstool (FST)**

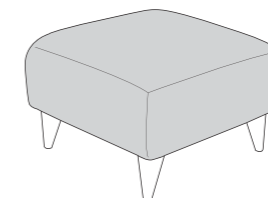

# LORNA DIMENSIONS (CM)

AVAILABLE PIECES	HEIGHT 1	WIDTH 2	DEPTH 3	SEAT HEIGHT 4	SEAT DEPTH (STD) 5	SEAT WIDTH 6	ACCESS DIAGONAL 7	WEIGHT (KG)	SCATTER CUSHIONS
L3, RFC, P GROUP or R3, LFC, P GROUP	92	282	251	53	56	N/A	N/A	100.5	2
L3/R3 UNIT	92	186	96	53	56	149	204	53	1
LFC/RFC UNIT	92	178	96	53	56	137	200	47.5	1
<b>3 SEATER SOFA</b>									
3 SEATER SOFA	93	203	97	50	56	127	218	70	2
<b>2 SEATER SOFA</b>									
2 SEATER SOFA	93	175	97	50	56	102	195	60	2
<b>LOVE CHAIR</b>									
LOVE CHAIR	93	136	97	50	56	63	160	52.5	2
<b>ARM CHAIR</b>									
ARM CHAIR	93	101	97	50	56	66	133	43	1
<b>SOFA BEDS - STD BACK ONLY</b>									
2S - 120cm STANDARD SOFA BED	93	175	97	50	56	99	193	73	2
2D - 120cm DELUXE SOFA BED	93	175	97	50	56	99	193	90.5	2
<b>OPEN DEPTH OF SOFA BEDS 226CM</b>									
<b>ACCENT PIECES</b>									
ACCENT CHAIR	80	67	78	47	50	N/A	84	12.5	N/A
FOOTSTOOL (P)	53	73	96	N/A	N/A	N/A	115	17	N/A
STORAGE STOOL (F)	43	63	50	N/A	N/A	N/A	75	13	N/A
LARGE STYLE FOOTSTOOL	40	103	63	N/A	N/A	N/A	115	15	N/A
SMALL STYLE FOOTSTOOL	40	63	63	N/A	N/A	N/A	83	11.5	N/A

\* Hardwood & composite board frame.

\* Dowelled, screwed, glued & stapled joinery.

\* Mid Oak & Dark Wood foot options.

\* Fibre filled scatters included.

\* Sumptuous feather filled arm pads for added comfort. 

\* Award winning foamflex seat interior with 5 year guarantee.

\* Serpentine seat springs & silent wire.

\* Superloop back springs.

## DIMENSION GUIDE

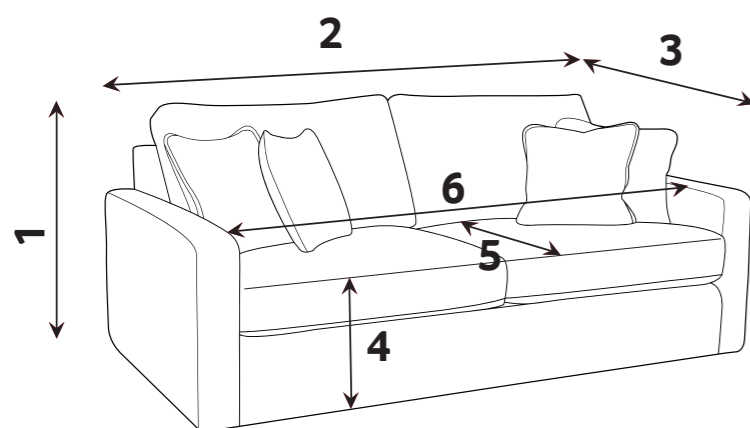

Check the diagonal access dimension to ensure furniture will fit in your home.

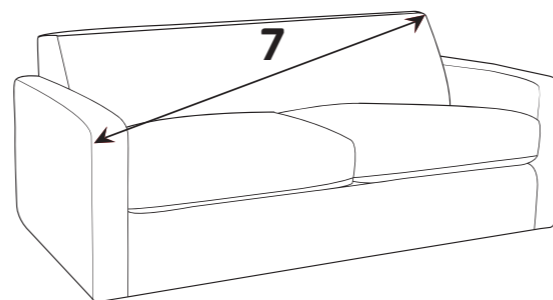

1 - HEIGHT  
2 - WIDTH

3 - DEPTH  
4 - SEAT HEIGHT

5 - SEAT DEPTH (STD & PILLOW)  
6 - SEAT WIDTH

7 - DIAGONAL ACCESS

Illustrations used for reference only.

Please note : All dimensions are approximate. Allow tolerance of +/- 2.5cm.

## SOFABEDS: 2 SLEEP OPTIONS

### STANDARD ACTION & FOAM MATTRESS

A three fold metal action with a sprung 'polyprop' base. Complemented by a high performance foam mattress. For occasional use only.

**Mattress Thickness: 6cm**

**Mattress Length: 185cm**

**3 fold action is 140Kg total max occupancy weight**

120cm sofa bed:

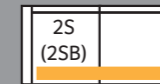

Mattress Width: 113cm



### DELUXE ACTION & SPRUNG MATTRESS

A two fold metal action with beech slats. Complemented by a deluxe sprung mattress. For everyday use.

**Mattress thickness: 11.5cm**

**Mattress Length: 183cm**

**2 fold action is 160Kg total max occupancy weight**

120cm sofa bed:

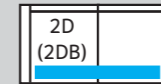

Mattress Width: 114cm



Sofa beds available as standard back only

## foamflex

Our new, expertly engineered foam seat interior gives you the comfort of fibre with the retention of foam.

## CARE GUIDE

To improve the longevity of your hand-made furniture, we recommend rotating cushions (where applicable). For further information on maintaining your furniture, please refer to the Care Guide located under the seat platform.



Our foamflex seat interiors have been granted the FIRA GOLD Award, a mark of quality under-pinning all necessary testing of the product materials, design and production techniques.

Convuluted Foam Topper

Doming Pad

High Density Base



Mid Oak

Dark (Antique)

### FOOT OPTIONS:



Wood is a natural product and will vary in shade/colour from item to item. Feet require fitting.

