



Cover 1:  
Burnaby Rust

Cover 2:  
Kairo Caramel

Cover 2:  
Otis Rust

Cover 3:  
Burnaby Rust

Cover 4:  
Larry Latte

Cover 1:  
Kairo Caramel

Cover 1:  
Burnaby Rust

Walnut Feet

Walnut Feet

Cover 1:  
Burnaby Rust

# Horatio Collection

Colours represented are to be used as a guide only.  
Please refer to manufacturers swatch for a more accurate colour match.

Please note that colour shadings can vary slightly from each roll of fabric.  
We cannot guarantee a precise match to these samples or between cut lengths and upholstered goods.



19/02/2024



# HORATIO COVER GUIDE: STANDARD BACK

Please use this guide when ordering the following pieces to clarify cover options.

4 Seater Modular Sofa - 4MD-S-C

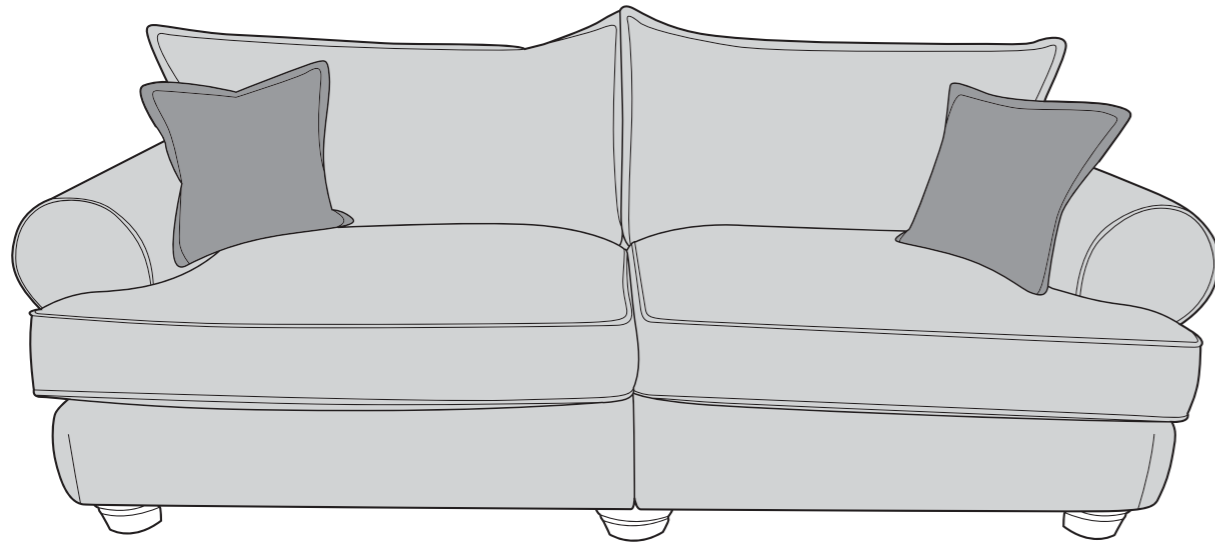

3 Seater Sofa 3ST-S-C

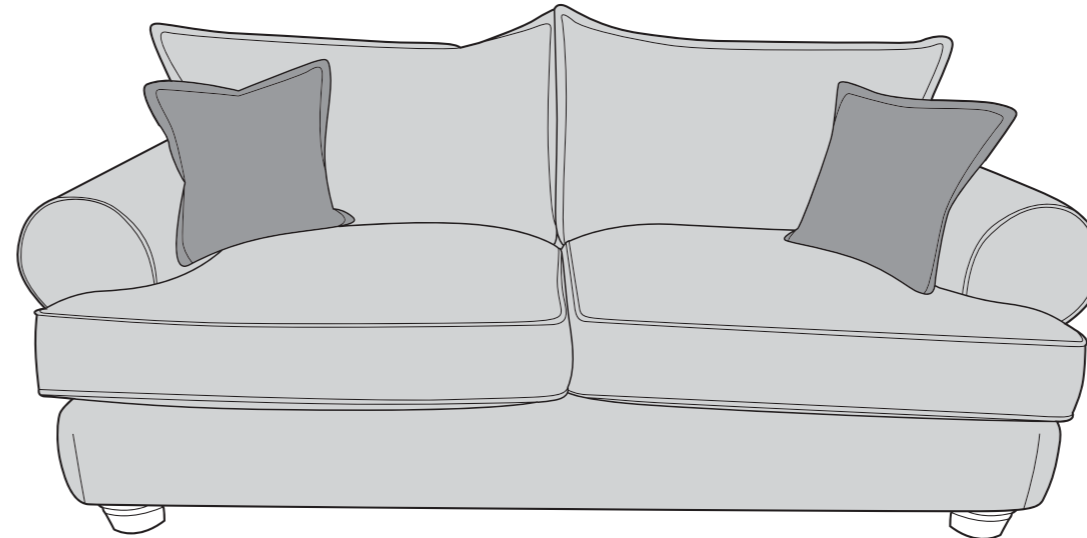

2 Seater Sofa - 2ST-S-C

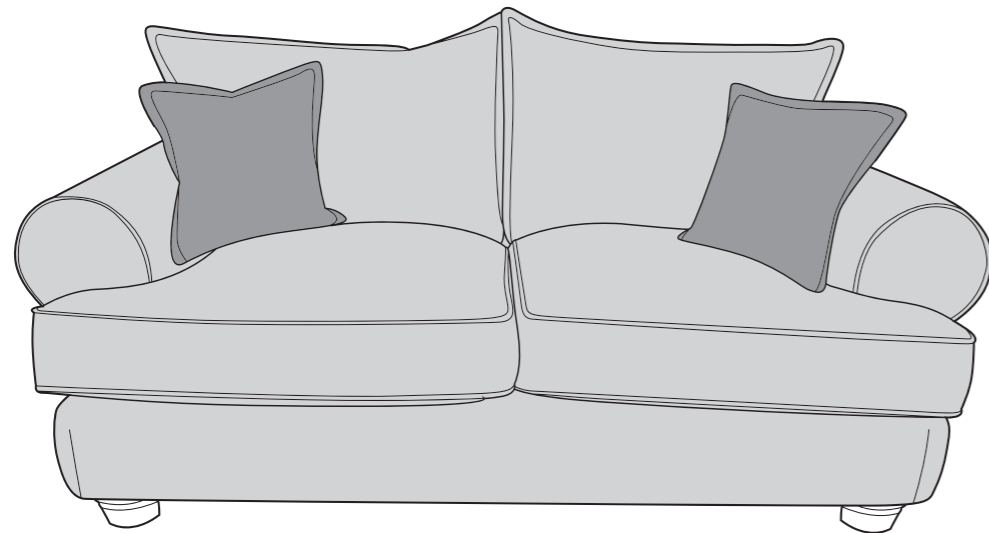

Love Chair - LOV-S-C

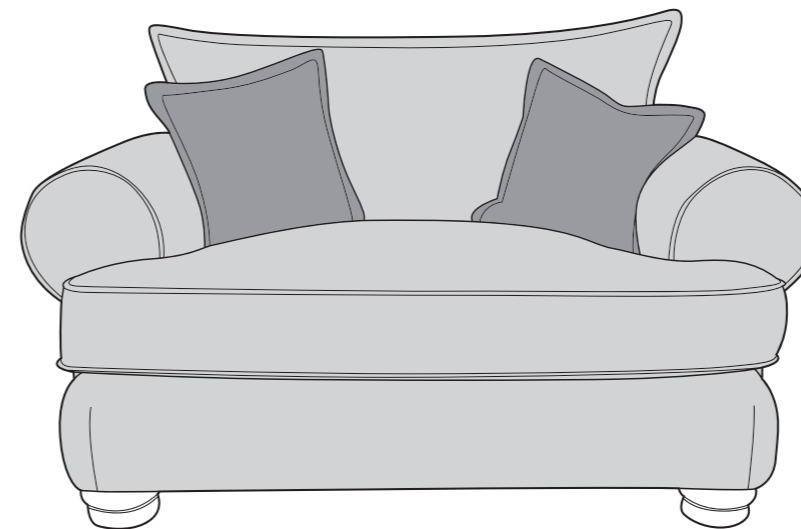

 **COVER 1**  
(BODY)

 **COVER 2**  
(SCATTER)

Standard back  
Scatter Cushions

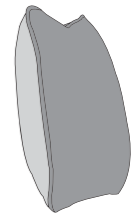

Front = Cover 2  
Back = Cover 1  
Flanged Edge



**APPROVED MEMBER**



# HORATIO COVER GUIDE: PILLOW BACK

Please use this guide when ordering the following pieces to clarify cover options.

4 Seater Modular Sofa - 4MD-P-C

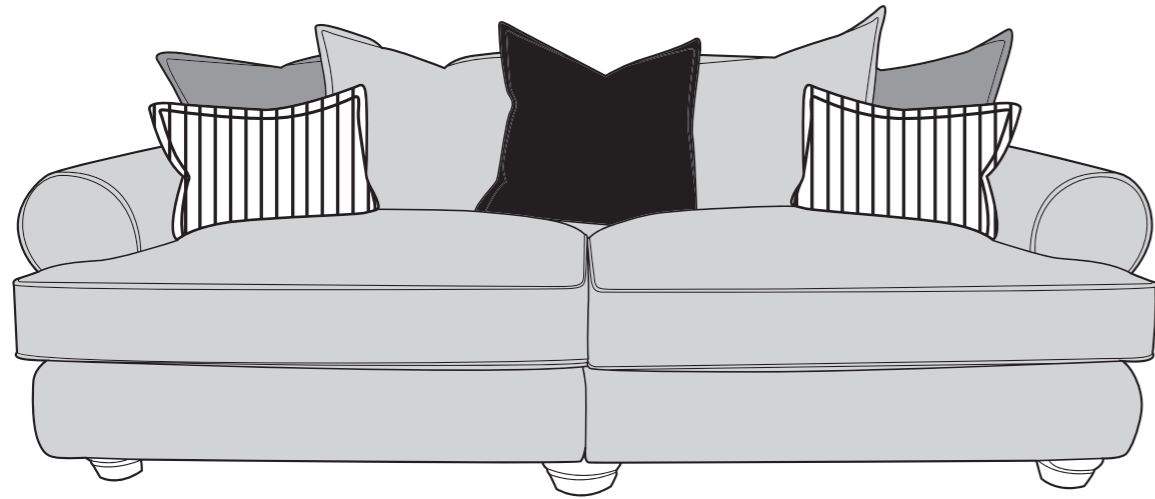

3 Seater Sofa - 3ST-P-C

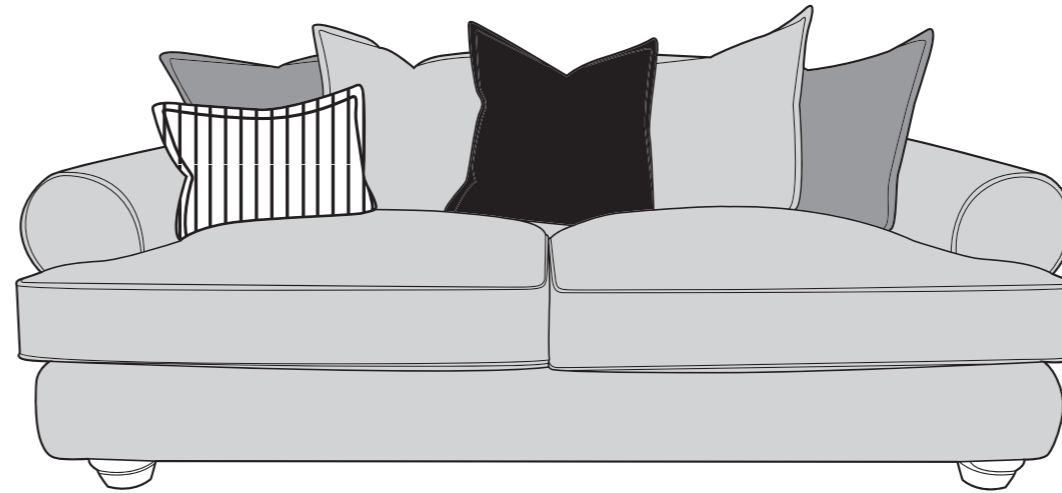

2 Seater Sofa - 2ST-P-C

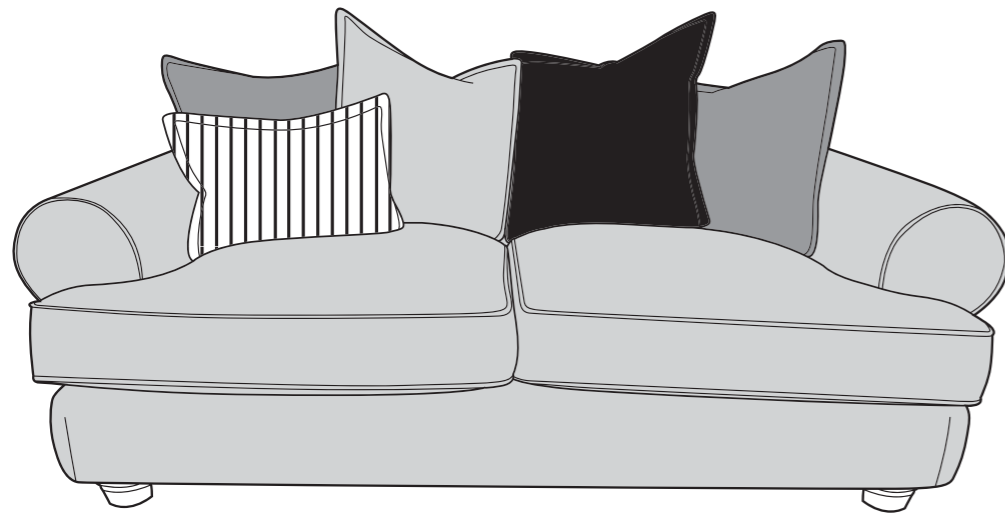

Love Chair - LOV-P-C

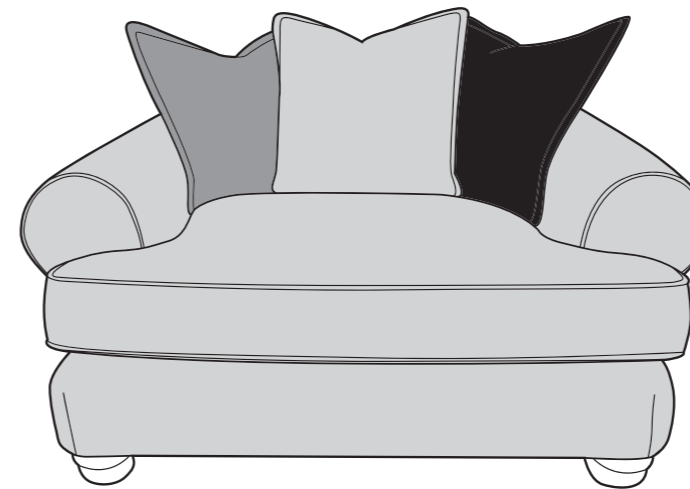

**COVER 1**  
(BODY)

**COVER 2**  
(PILLOW)

**COVER 3**  
(PILLOW)

**COVER 4**  
(BOLSTER)

**Pillow Back Cushions**

Flanged Edge Front = Cover 1 Back = Cover 1

Flanged Edge Front = Cover 2 Back = Cover 1

Flanged Edge Front = Cover 3 Back = Cover 1

**Bolster Cushion**

Front = Cover 4  
Back = Cover 4  
Flanged Edge

## SUGGESTED ACCENT PIECES

Horatio Footstool (FST)

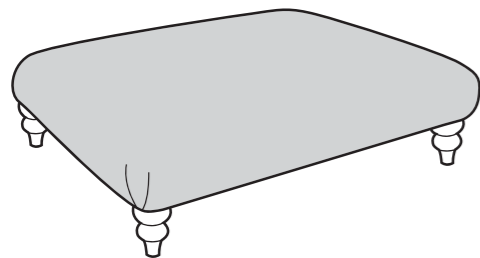

Kenneth Accent Chair (ACH)

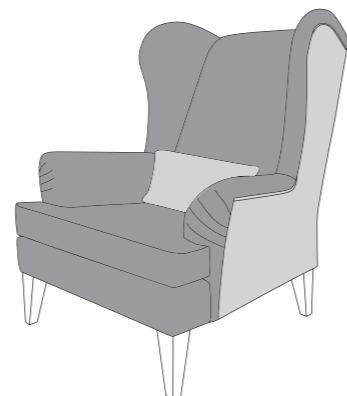

**COVER 1**  
(OUTER / BOLSTER FRONT)

**COVER 2**  
(INNER / BOLSTER BACK)

**Bolster Cushion**

Front = Cover 1  
Back = Cover 2  
Flanged Edge



APPROVED MEMBER



# HORATIO DIMENSIONS (CM)

AVAILABLE PIECES	HEIGHT 1	WIDTH 2	DEPTH 3	SEAT HEIGHT 4	SEAT DEPTH 5	SEAT WIDTH 6	ACCESS DIAGONAL 7	OUTBACK HEIGHT 8	ARM HEIGHT 9	WEIGHT (KG)	SCATTER CUSHIONS / BOLSTERS
4 SEATER MODULAR SOFA (4MD)	86	246	106	49	70	188	248	70	63	80	SB = 2 x SCATTER PB = 2 x BOLSTER
4ML/4MR UNIT	86	123	106	49	70	94	147	70	63	40	SB = 1 x SCATTER PB = 1 x BOLSTER
3 SEATER SOFA (3ST)	86	209	106	49	70	157	221	70	63	65	SB = 2 x SCATTER PB = 1 x BOLSTER
2 SEATER SOFA (2ST)	86	189	106	49	70	134	203	70	63	59.5	SB = 2 x SCATTER PB = 1 x BOLSTER
LOVE CHAIR (LOV)	86	147	106	49	70	91	168	70	63	50.5	SB = 2 x SCATTER
<b>ACCENT PIECES</b>											
KENNETH ACCENT CHAIR (ACH)	114	98	108	56	54	62	130	N/A	63	34	N/A
HORATIO FOOTSTOOL (FST)	29	93	93	N/A	N/A	N/A	114	N/A	N/A	18	N/A

\* Hardwood & composite board frame.

\* Dowelled, screwed, glued & stapled joinery.

\* Available with a Walnut wood foot.

\* Featherflex seat interior. 

\* Standard Back with fibre filled backs for added comfort and feather filled scatters. 

\* Pillow Back with sumptuous feather filled pillow backs and feather bolsters 

\* Serpentine seat springs & silent wire.

\* Elasticated back webbing.

## DIMENSION GUIDE

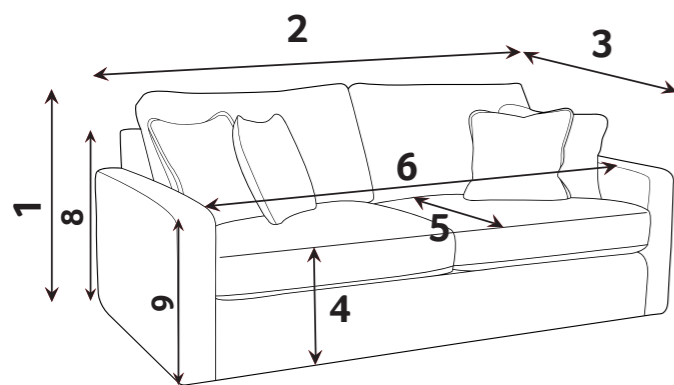

- 1 - HEIGHT
- 2 - WIDTH
- 3 - DEPTH
- 4 - SEAT HEIGHT
- 5 - SEAT DEPTH (STD & PILLOW)
- 6 - SEAT WIDTH
- 7 - DIAGONAL ACCESS
- 8 - OUTBACK HEIGHT
- 9 - ARM HEIGHT

Illustrations used for reference only.

Check the diagonal access dimension to ensure furniture will fit in your home.

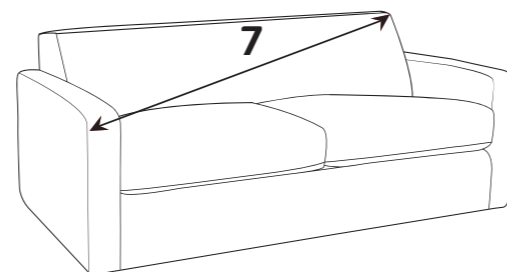

A high density foam base seat interior with a duck feather filled, channelled topper which provides both luxurious softness and support.

## CARE GUIDE

Featherflex seat cushions should be plumped up on a regular basis to help maintain the aesthetical appeal and longevity of your upholstery.

For further information on maintaining your furniture please refer to the care guide located under the seat platform.

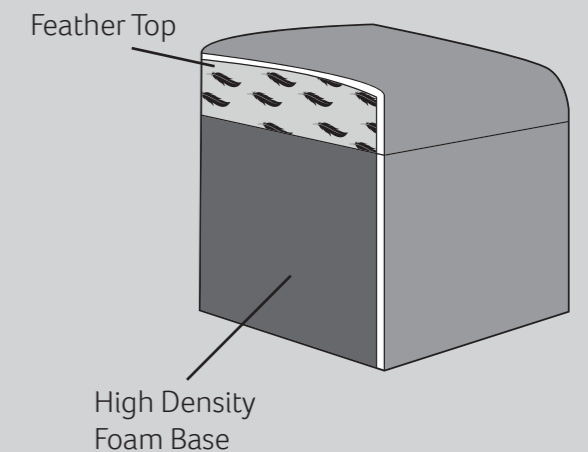

Front Foot - Walnut

Back Foot - Walnut

## FOOT OPTIONS:

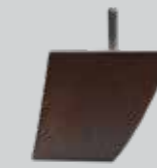

Wood is a natural product and will vary in shade/colour from item to item. Feet may require fitting.

Please note : All dimension are approximate. Allow tolerance of +/- 2.5cm.

