



Cover 2:
Penthouse Gold

Cover 1:
Jive Silver

Gold Piping

Blaise Collection

Colours represented are to be used as a guide only.
Please refer to manufacturers swatch for a more accurate colour match.

Please note that colour shadings can vary slightly from each roll of fabric.
We cannot guarantee a precise match to these samples or between cut lengths and upholstered goods.

foamflex™
Award Winning Seating Technology

10/10/2023

BLAISE COVER GUIDE: STANDARD BACK ONLY

Please use this guide when ordering the following pieces to clarify cover options.

Corner Group: LH2, COR, RH2

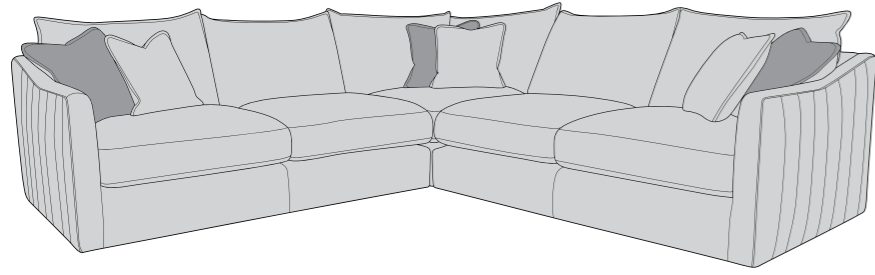

Corner Group: LH2, COR, RH1

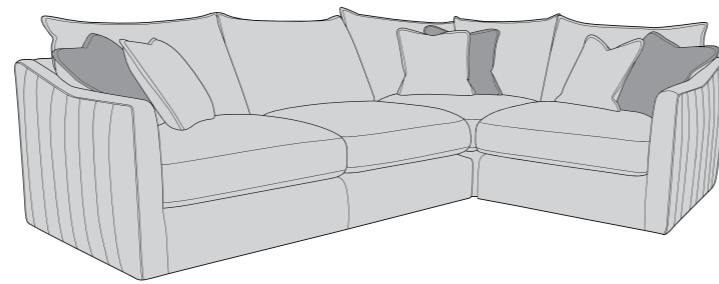

Corner Group: LH1, COR, RH2

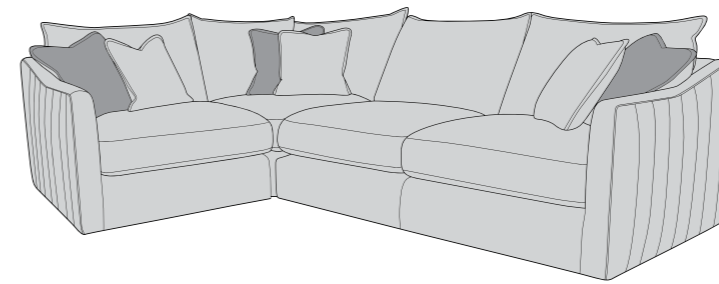

Corner Group: LH1, COR, RH1

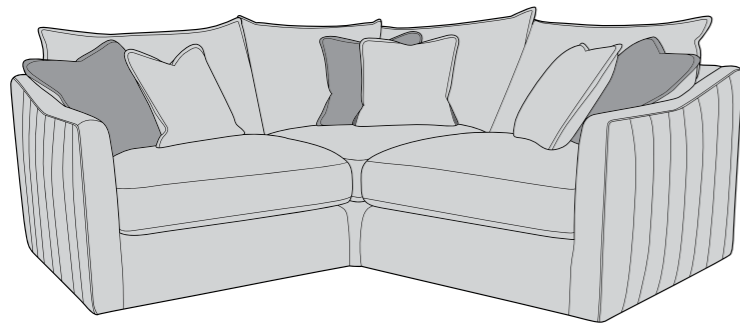

3 Seater Sofa (3ST)

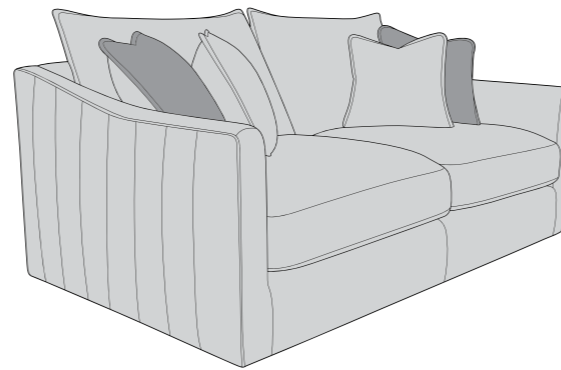

2 Seater Sofa (2ST)

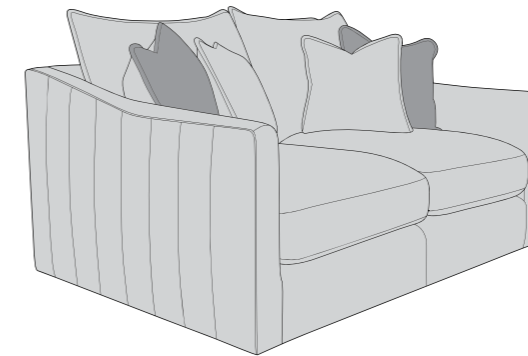

Arm Chair (1ST)

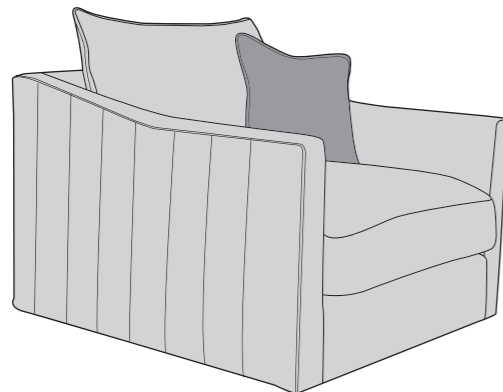

Armless Unit (ALU)

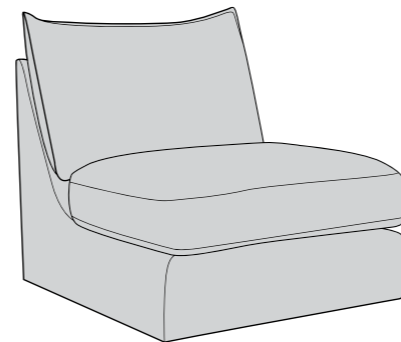

Blaise
Large Footstool (FST)

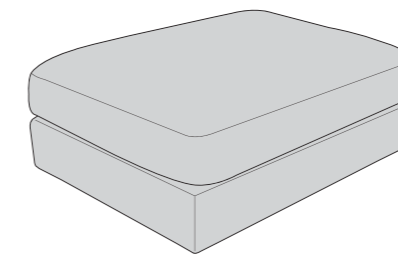

- COVER 1**
(BODY & SMALL SCATTERS)
- COVER 2**
(MEDIUM SCATTERS, SMALL ON CHAIR)

Scatter Cushions
Medium Scatters
(small on chair)

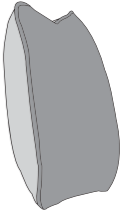

Flanged Edge
Front = Cover 2
Back = Cover 1

Small Scatters

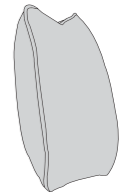

Flanged Edge
Front = Cover 1
Back = Cover 1



BLAISE DIMENSIONS (CM)

AVAILABLE PIECES	HEIGHT 1	WIDTH 2	DEPTH 3	SEAT HEIGHT 4	SEAT DEPTH 5	SEAT WIDTH 6	ACCESS DIAGONAL 7	OUTBACK HEIGHT 8	ARM HEIGHT 9	WEIGHT (KG)	SCATTER CUSHION NO.
LH2, COR, RH2 GROUP	88	272	272	47	N/A	N/A	N/A	70	60	140	6 (3 Medium, 3 Small)
LH2, COR, RH1 GROUP or LH1, COR, RH2 GROUP	88	272	195	47	N/A	N/A	N/A	70	60	124	6 (3 Medium, 3 Small)
LH1, COR, RH1 GROUP	88	195	195	47	N/A	N/A	N/A	70	60	108	6 (3 Medium, 3 Small)
LH2/RH2 UNIT	88	167	105	47	66	155	194	70	60	52	2 (1 Medium, 1 Small)
LH1/RH1 UNIT	88	90	105	47	66	N/A	N/A	70	60	36	2 (1 Medium, 1 Small)
COR - CORNER UNIT	88	105	105	47	66	N/A	145	70	N/A	36	2 (1 Medium, 1 Small)
ALU - ARMLESS UNIT	88	75	105	47	66	N/A	129	70	N/A	25	N/A
BLAISE FOOTSTOOL (FST)	47	105	78	N/A	N/A	N/A	128	N/A	N/A	18	N/A



* Hardwood & composite board frame.

* Dowelled, screwed, glued & stapled joinery.

* Gold, Chrome and Black piping available.

* Fibre filled reversible backs for added comfort.

* Feather filled scatters included.



* Award winning foamflex seat interior with 5 year guarantee.

* Serpentine seat springs & silent wire.

* Elasticated back webbing.

DIMENSION GUIDE

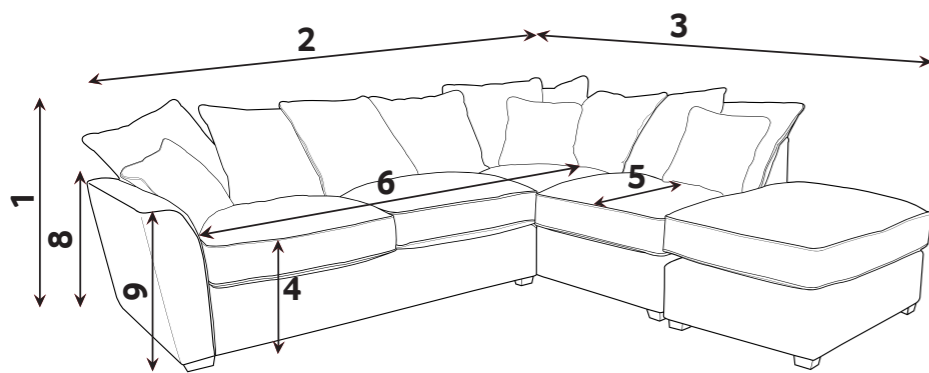

1 - HEIGHT
2 - WIDTH

3 - DEPTH
4 - SEAT HEIGHT

5 - SEAT DEPTH (STD & PILLOW)
6 - SEAT WIDTH

7 - DIAGONAL ACCESS
8 - OUTBACK HEIGHT
9 - ARM HEIGHT

Illustrations used for reference only.

Check the diagonal access dimension to ensure furniture will fit in your home.

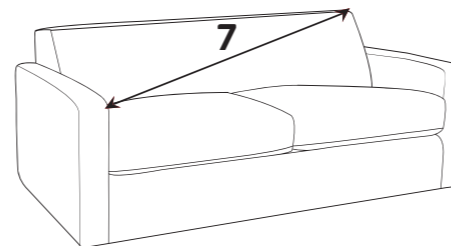

foamflex™

Our new expertly engineered foam seat interior gives you the comfort of fibre with the retention of foam.

CARE GUIDE

To improve the longevity of your hand-made furniture, we recommend rotating cushions (where applicable).

For further information on maintaining your furniture, please refer to the Care Guide located under the seat platform.



Our foamflex seat interiors have been granted the FIRA GOLD Award, a mark of quality underpinning all necessary testing of the product materials, design and production techniques.

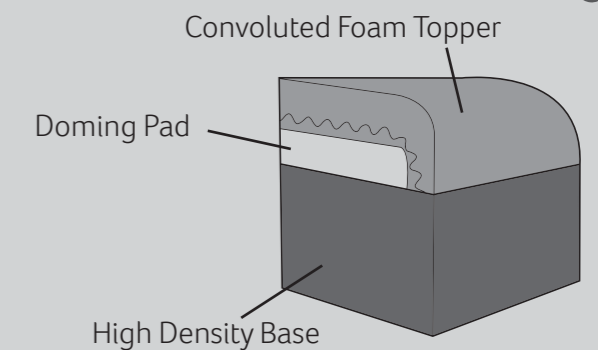

A choice of Gold, Chrome or Black piping is available except on accent pieces and armless unit.

